

52" CEILING FANS

Instruction Manual

SAFETY GUIDELINES AND INSTALLATION PROCEDURES



RCF-ONDULAR-3B

(SW720-301-WH)

(SW720-301-BK)

(SW720-301-MB)

TBA

TBA

WHAT YOU HAVE

Please checkout following parts after opening the box

PARTS	QUANTITY	SCREW PACKAGE	QUANTITY
1. DOWNROD (WOBBLE-FREE ASSEMBLY)	1	9. BLADE ATTACHMENT SCREWS	10
2. TOP CANOPY	1	10. HEX-HEAD SCREWS	2
3. COUPLING COVER	1	11. EXPANSION J HOOK	1
4. MOTOR COUPLING	1		
5. FAN MOTOR	1		
6. BLADES	3		
7. TRANSMITTER WITH 12V BATTERY	1		
7A. TRANSMITTER HOLDER WITH 2 MOUNTING SCREWS	1		
8. RECEIVER	1		

COMPONENTS

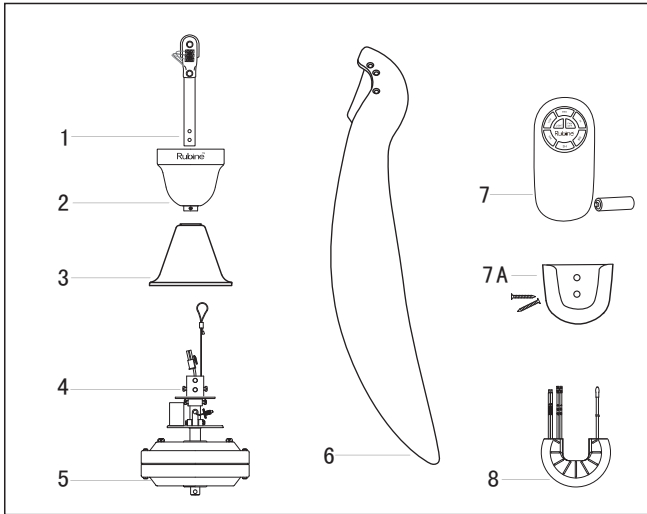

SCREW PACKAGE

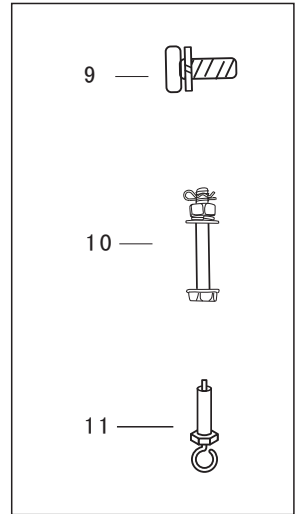

FAN SIZE	VOLTAGE	MAX. FAN POWER	MAX SPEED (RPM)	PRODUCT WEIGHT	CARTON WEIGHT
52"	220-240V/50Hz	100W	200±10%	6.20kgs	7.45 kgs

WARNING

A). TO ENSURE YOUR PERSONAL SAFETY, PLEASE READ THROUGH THE INSTRUCTION MANUAL BEFORE USE

- 1) Do not bend the blade holders during installation, blades balancing or fan cleaning.
- 2) To prevent accidents, power switch must be OFF before ceiling fan installation.
- 3) Ceiling fan installation and electrical wiring must be done by qualified technician in accordance with all applicable codes and air conditioning engineers (ASHRAE) or the local qualified authorities.
- 4) Be cautious when drilling the wall to avoid damaging electrical wiring and other hidden parts.
- 5) Ceiling fan must be hooked on concrete ceiling. Do not install the ceiling fan on plaster ceiling or any types of drywall ceilings. During ceiling fan installation, all screws must be tightened at all allocated parts.

B). SAFETY GUIDELINES

- 1) Please do not install the ceiling fan at high humidity areas.
- 2) The fan is to be installed so that the blades are more than 2,3 m above the floor.
- 3) Do not touch fan blades with any objects when the ceiling fan is spinning.
- 4) To minimize the chances of electrical shock, power switch must be OFF before installing or dismantling the ceiling fan or any electrical wiring connection.
- 5) All electrical connections must conform to the national electrical safety codes. To prevent electrical shock, earth wire must be installed correctly (suitable for power supply of 220-240V AC/50Hz).
- 6) To ensure your personal safety and optimize functions of the ceiling fan, assembly and installation by qualified technician is highly recommended.
- 7) Only direct connection to wall switch is allowed. Please refer to diagram below.

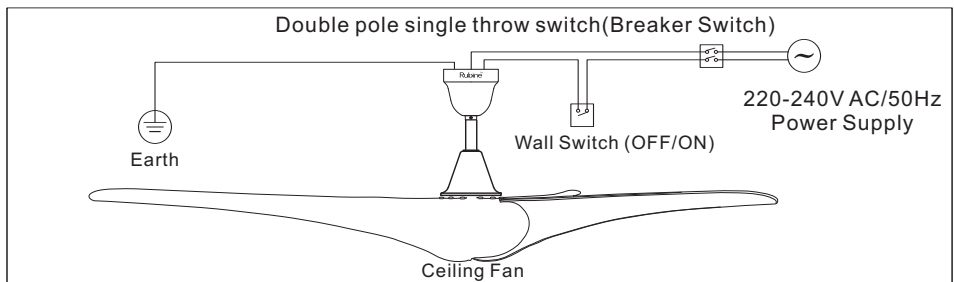

- 8) This product is not provided with cord, plug or other means for disconnection from the supply. Connecting or changing power cord or lead wire, must be done by qualified personnel in order to avoid hazard.
- 9) This appliance is not intended for use by persons (including children) with reduced physical, sensory or mental capabilities, or lack of experience and knowledge, unless they have been given supervision or instruction concerning use of the appliance by a person responsible for their safety.
- 10) Children should be supervised to ensure that they do not play with the appliance.
- 11) The appliance is fitted with means for disconnection from the supply mains having a contact separation in all poles that provide full disconnection under overvoltage category III conditions, and these means must be incorporated in the fixed wiring in accordance with the wiring rules.

INSTALLATION PROCEDURES

Before ceiling fan installation, please go through the procedures in detail with picture diagrams as reference.

STEP 1 (See Diagram 1)

- 1) Align the 3 holes from the blade to the fan motor.
- 2) Secure blade with 3 blade screws provided. Follow the same process for the remaining two blades.

DIAGRAM 1

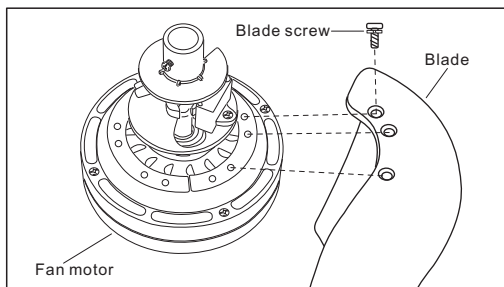

STEP 2 (See Diagram 2)

- 1) Remove 1st hex-head screw along with the fixings (pin, metal nut, lock washer and metal washer) from the downrod.
- 2) Remove the pin on 2nd hex-head screw and loosen the other fixings.

DIAGRAM 2

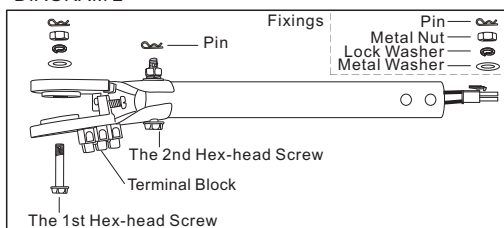

STEP 3 (See Diagram 3)

- 1) Loosen 2 screws on the motor coupling.
- 2) Insert the downrod through top canopy and coupling cover.
- 3) Thread the safety cable through the downrod.
- 4) Connect both connectors from the downrod and fan motor.
- 5) Lock the downrod to the motor coupling, tighten up with 2 hex-head screws and fixings.
- 6) Tighten 2 screws on the motor coupling.
- 7) Slide down the coupling cover until it rest on top of the fan housing.

DIAGRAM 3

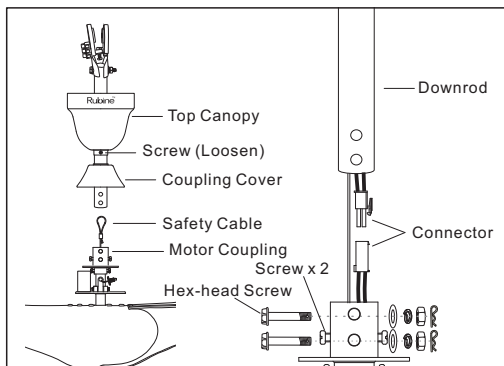

STEP 4 (See Diagram 4)

- 1) Lift the wobble-free assembly onto the mounted hook.
- 2) Install the 1st hex-head screw together with fixings.
- 3) Tighten up the 2nd hex-head screw and fixing.
- 4) Tighten the 2 screws in the middle of wobble-free assembly.

Note:-

1. Remember to lock the pin after tightening hex-head screws.
2. Hook must be installed on concrete ceiling.

DIAGRAM 4

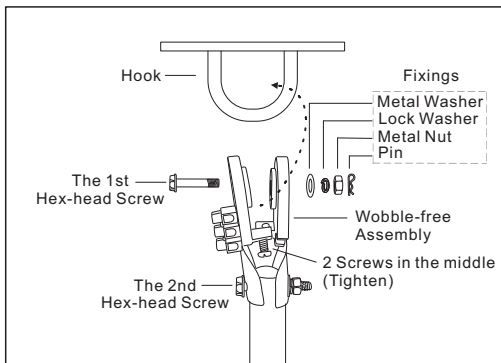

WARNING:

Installation without proper procedures as above mentioned might result to fan loosening or falling.

STEP 5 (See Diagram 5)

	Connect the Motor Wiring to Receiver first!
--	---

Connect wiring as below:-

FROM		TO	
Receiver	Brown Wire (TO MOTOR L)	Terminal Block (marked“L”)	
Receiver	Blue Wire (TO MOTOR N)	Terminal Block (marked“N”)	
Ceiling	Green Wire (Incoming EARTH Wire)	Terminal Block (marked“⊕”)	
Ceiling	Red / Brown Wire (Incoming LIVE Wire)	Receiver	Red Wire (AC in L)
Ceiling	Black / Blue Wire (Incoming NEUTRAL Wire)	Receiver	Black Wire (AC in N)

DIAGRAM 5

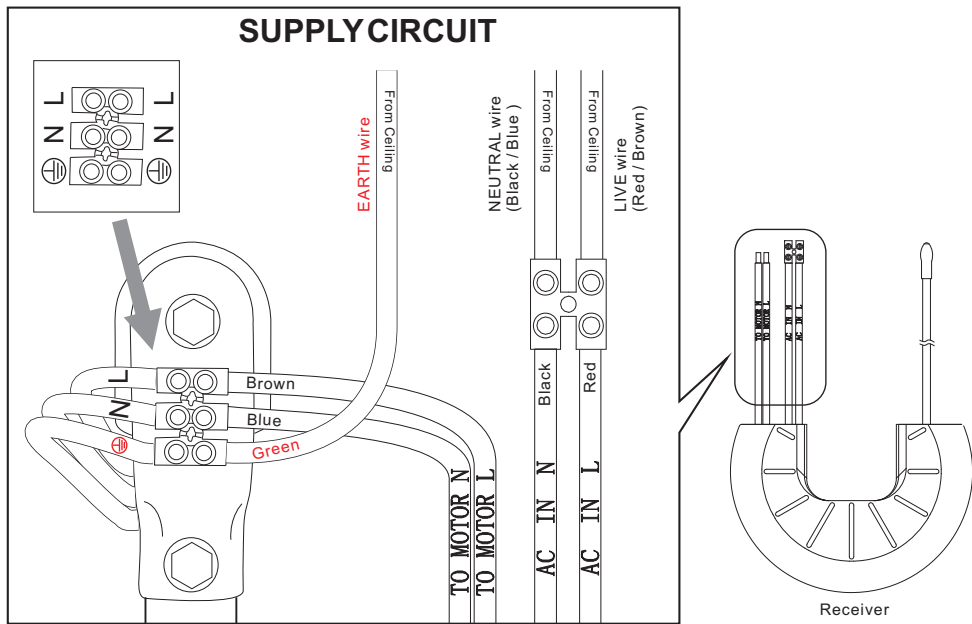

STEP 5 (See Diagram 5)

Fit the connected receiver into top canopy. Then, tug the top canopy to ceiling and tighten up the screw on down rod to secure the top canopy.

DIAGRAM 5

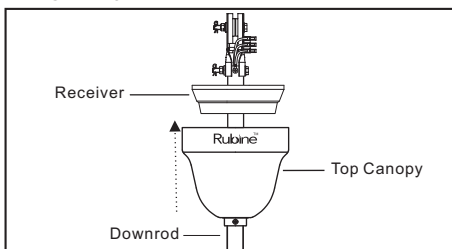

WARNING!

FASTEN THE SAFETY CABLE TO THE MOUNTED EXPANSION J HOOK FOR SAFETY PURPOSES.

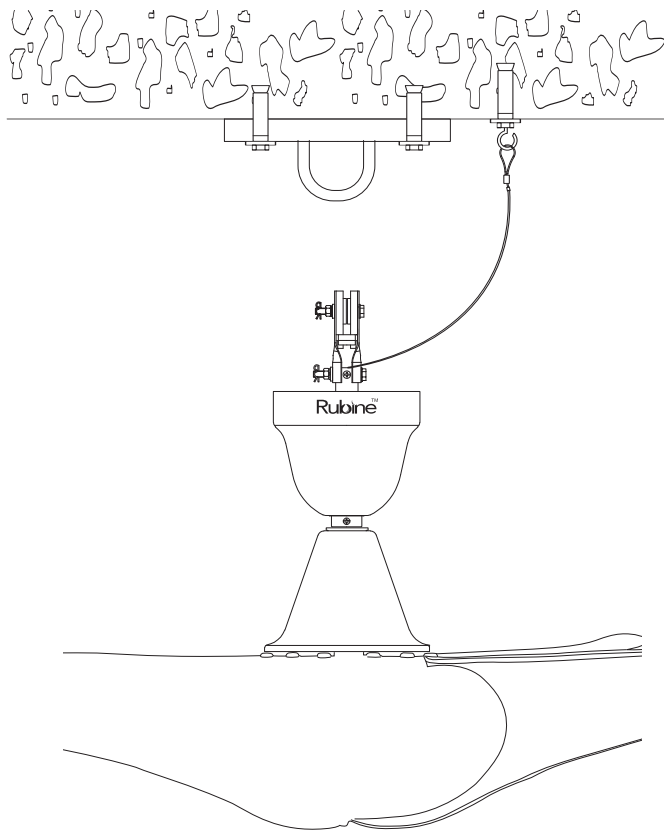

SAFETY TIPS:

The fan is to be installed so that the blades are more than 2,3 m above the floor.

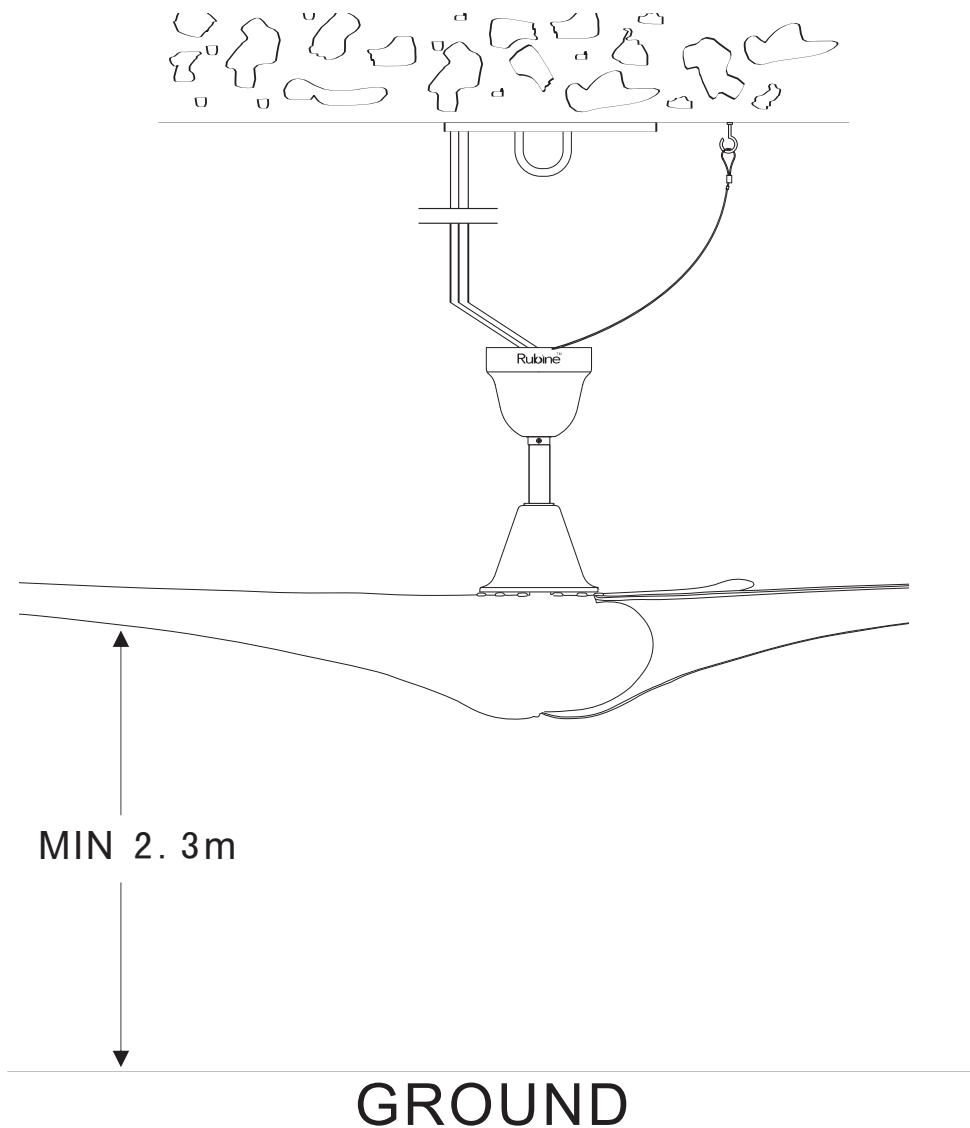

52"

吊扇

安装手册

安全注意事项和安装程序



RCF-ONDULAR-3B

(SW720-301-WH)

(SW720-301-BK)

(SW720-301-MB)

TBA

TBA

配件明细

拆箱后，请逐一清点以下零件

零件	数量	配件包	数量
1. 吊杆（吊挂系统）	1	9. 叶片螺丝	10
2. 吊盘	1	10. 螺栓	2
3. 接头盖	1	11. 安全挂钩	1
4. 马达接头	1		
5. 风扇主体	1		
6. 叶片	3		
7. 遥控器附12V电池	1		
7A. 壁座附带2个螺丝	1		
8. 接收器	1		

元 件

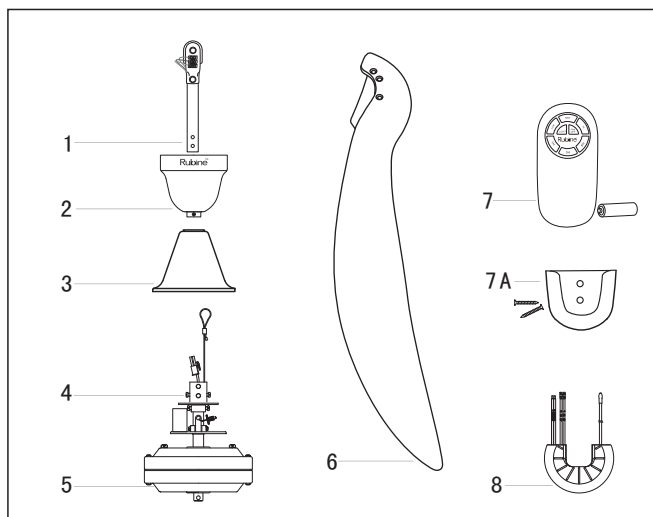

配件包

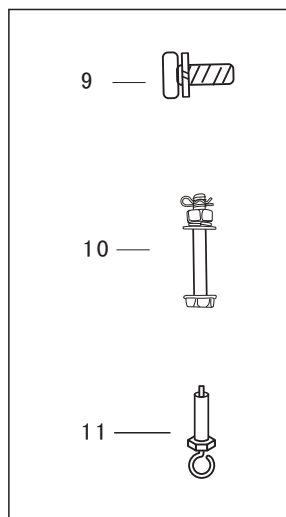

尺寸	电压/频率	风扇最大功率	最大转速	净重	毛重
52"	220-240V/50Hz	100W	200±10%	6.20kgs	7.45kgs

警 告

A) 为了确保您的人身安全，使用前请详细阅读说明书

1. 在安装叶架，平衡叶片或清洁风扇的时候，不能将叶架弯曲。
2. 安装此吊扇前必须关闭电源开关，以免造成意外。
3. 此吊扇的安装和接电应由技术熟练的电工完成。
4. 注意钻墙的时候不要损坏电线和其它隐藏的零件。
5. 吊扇必须悬挂在坚定稳固的天花板上，吊扇安装时，各部分螺丝必须锁牢。

B) 安全注意事项

1. 请不要将吊扇安装在潮湿的地方。
2. 安装吊扇时，叶片至少离地面2.3米高处，以防与叶片发生意外碰触。
3. 吊扇运转时，请不要用任何物品碰触叶片，以免危险。
4. 为了减少触电事故发生，安装电线或拆装风扇前请及时关电源开关。
5. 所有的接电必须符合国家安全要求的标准，为了避免意外触电，确保吊扇接地线生效（适用于220-240V供电）。
6. 为了确保您的安全和产品的使用达到最佳效果，建议要技术熟练的技工来安装此风扇。
7. 只允许直接连接墙开关，请参考下图。

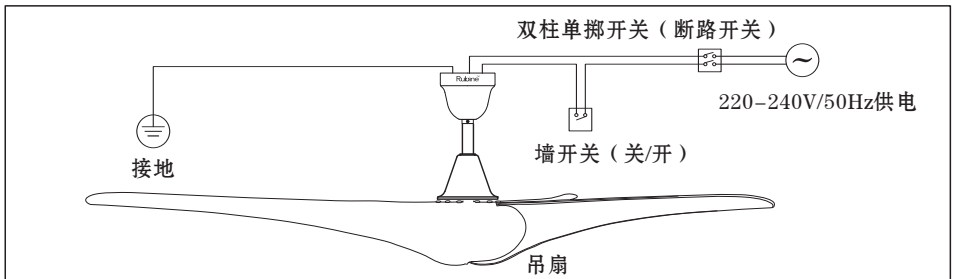

8. 本产品没有提供插头或其他绝缘体，连接或更换电线的时候，建议请资深的技工操作，以免造成危险。
9. 本产品不打算由这些人（包括儿童）来使用：身体上，感觉上或者精神上有缺陷者，或缺乏经验和知识者。除非他们得到了在对其安全负责的人关于该项产品使用的监护或指导（对所有产品）。
10. 儿童应当受到监督以确保其不会玩耍器具（对所有产品）
11. 本产品已配有双极断开装置(过电压等级III条下)，按布线规则，其连接的固定布线必须配有这样的断开装置。

安装程序

为了确保顺利安装此吊扇，请详细阅读以下步骤，并参照插图。

步骤1（图1）

- 1) 用叶片上的三个螺丝与风扇马达上相对应的螺丝孔一一对齐。
- 2) 用螺丝包的叶片螺丝将叶片锁紧在风扇马达上。

图1

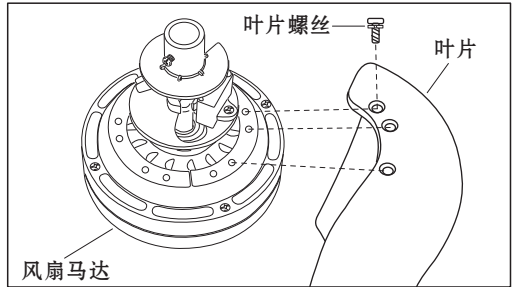

步骤2（图2）

- 1) 把吊杆上第一个螺栓和其他配件一起拆下（R销，螺母，弹介和平华司）。
- 2) 把第二个螺栓上的R销拆下，松开其他配件。

图2

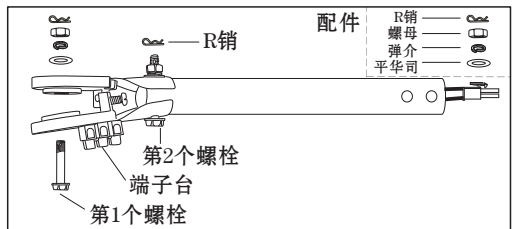

步骤3（图3）

- 1) 松开马达接头上的2颗预锁螺丝。
- 2) 将吊杆穿入吊盅和接头盖。
- 3) 将安全钢索穿过吊杆。
- 4) 把马达上的接线套接到吊杆的接线套上。
- 5) 将吊杆套入马达接头处，对准孔，用配件包里的螺栓锁上。
- 6) 锁紧之前松开的螺丝。
- 7) 把接头盖移至马达的上端。

图3

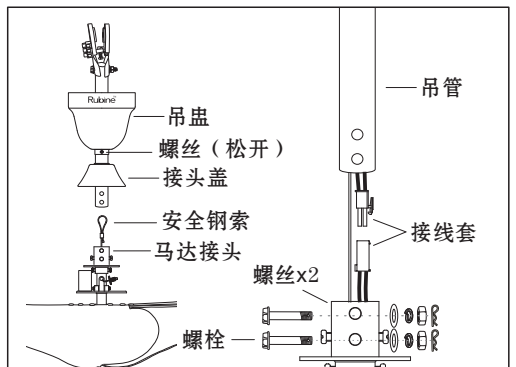

步骤4 (图4)

- 1) 将吊扇挂上已装紧的吊钩上。
- 2) 装上之前拆下的第一个螺栓和其他配件。
- 3) 拧紧第二个螺栓上的配件。
- 4) 拧紧吊挂系统上的2颗螺丝。

注意：-

1. 记得插上R销。
2. 吊钩必须安装在坚固的天花板上。

图4

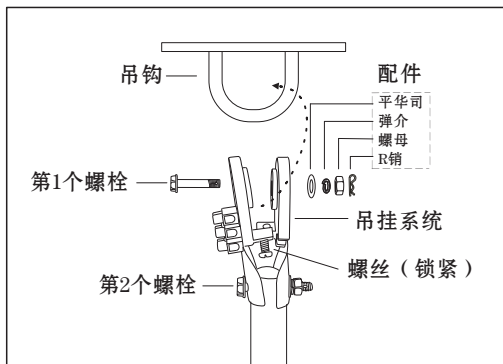

警告

如果没有按照上面指示把吊杆装紧，有可能导致吊扇下坠。

步骤5 (图5) :

 接收器必须先与风扇接好线

接线如下 :-

出线		接线	
接收器	棕色电线 (TO MOTOR L)	端子台 (标注 “L”)	
接收器	蓝色电线 (TO MOTOR N)	端子台 (标注 “N”)	
天花板	绿色 (天花板地线)	端子台 (标注 “Ⓧ”)	
天花板	红色 / 棕色 (天花板火线)	接收器	红色电线 (AC in L)
天花板	黑色 / 蓝色 (天花板零线)	接收器	黑色电线 (AC in N)

图5

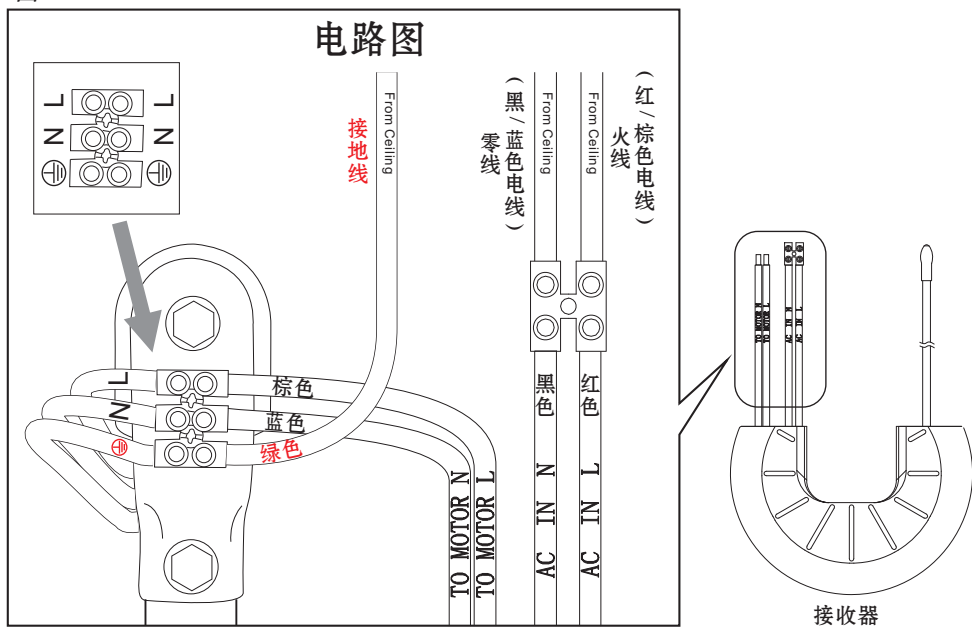

步骤6 (图6)

把接收器放进吊钟里面，把吊钟移至吊杆上端，使吊钟与天花板贴紧，锁紧螺丝并把吊钟固定。

图6

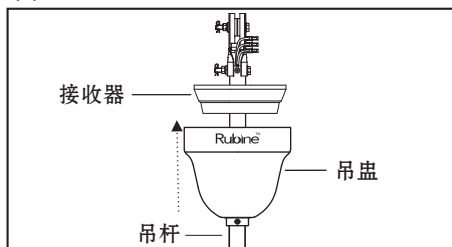

警 示

为了安全起见，请把安全吊钩装紧在天花板上，再把安全钢丝挂在吊钩上。

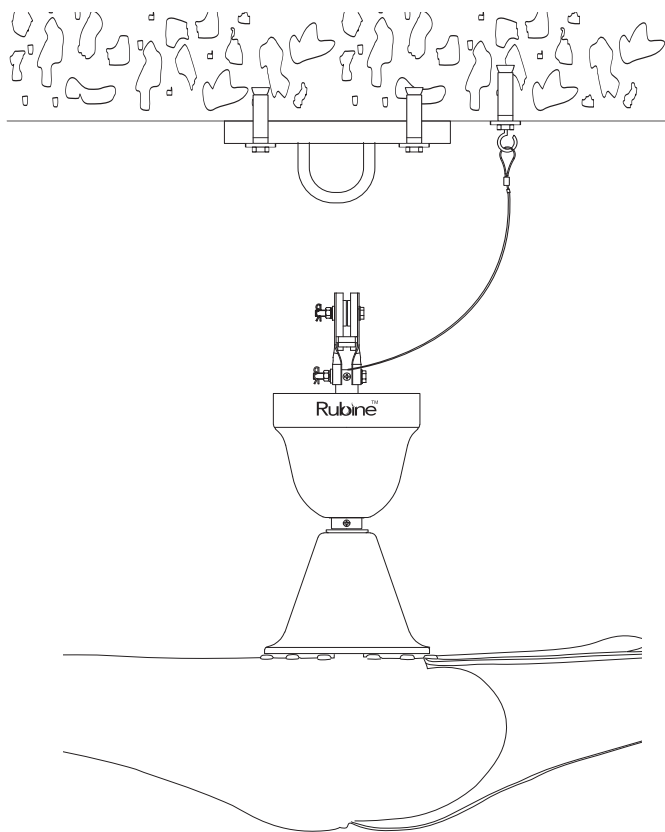

安全提示：

安全起见，请确保叶片距离地面至少2.3米或以上。

